

MARKANT

Apod X

Specsheet





sizes adaptable
for any
workspace

6 different solutions

acoustic
attenuation
rate
*according to
ISO 23351-1

30.2 db

ISO 23351
certification

Class - A

after
installation
warranty

2 years

Organic softness MDF powder coating

Apod X Respects nature and human

Apod X combines aesthetics, functionality, and sustainability in modern living spaces.

The exterior wall of Apod X is using eco-friendly and non-toxic MDF Powder Coating technology. A significant innovation supporting the sustainable and eco-friendly lifestyle; MDF Powder Coated surfaces are free from environmentally and health-threatening substances like lead, mercury, and solvents, is odor-free and boasts antibacterial and antiallergic properties.

In comparison to traditional liquid paints, this advanced painting method substantially diminishes environmental impact with 0% waste rate during painting process and durable surface coverage; contributing to an enhanced level of sustainability.

Beyond being a crucial step towards a sustainable future, the impressive design with a subtle textured appearance matte finish also enhances the aesthetic appeal in work environments.



Easy to Clean



Durable



Odorless



Moisture Resistant



Low Hazard Risk of Fire



100% Healthy Eco-Friendly



Anti-allergic Antibacterial



Non-Toxic

Certificates





Product family



Apod X Small 100x110x227 cm

- Adjustable lighting & ventilation system
- Stainless steel door threshold
- 12 mm thick single-piece glass door
- Occupancy sensor option
- Wheels and adjustable leveling feet
- Optional desktop electrification system
- Optional fixed or height-adjustable table

Perfect silence for **phone calls**.



Apod X Zoom 100x140x227 cm

- Adjustable lighting & ventilation system
- Stainless steel door threshold
- 12 mm thick single-piece glass door
- Occupancy sensor option
- Horizontal sliding desk at fixed height
- Media Wall option with integrated face lights
- Wheels and adjustable leveling feet
- 1x soft seating

Connect to the world **with setenity**.



Apod X Large 100x220x227 cm

- Adjustable lighting & ventilation system
- Stainless steel door threshold
- 12 mm thick single-piece glass door
- Occupancy sensor option
- Integrated power socket
- Soft seating option
- TV bracket and HDMI option
- Wheels and adjustable leveling feet

The ideal focus point for **two-person meetings**.



Apod X Four 140x220x227 cm

- Adjustable lighting & ventilation system
- Stainless steel door threshold
- 12 mm thick single-piece glass door
- Occupancy sensor option
- Integrated power socket
- 2x soft seating option
- Fixed desk
- TV bracket and HDMI option
- Wheels and adjustable leveling feet

Enhance your team's strength **with superior acoustic comfort.**



Apod Double X 180x220x227 cm

- Adjustable lighting & ventilation system
- Stainless steel door threshold
- 12 mm thick single-piece glass door
- Occupancy sensor option
- Integrated power socket
- TV bracket and HDMI option
- Adjustable leveling feet

Efficient meetings with **high-level silence.**

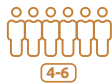

Apod Triple X 220x270x227 cm

- Adjustable lighting & ventilation system
- Stainless steel door threshold
- 12 mm thick single-piece glass door
- Occupancy sensor option
- Integrated power socket
- TV bracket and HDMI option
- Adjustable leveling feet

A unique working environment **for exceptional teams.**

Technical specification

- Table***
 - MDF Powder Coated with matte finish
 - Height Adjustable (68 to 118cm) or Fixed Height (96 cm)
 - Max. weight carriage 50 kgs
- Sound Absorbent Felt Fabric**
 - 50% recycled PET felt fabric
 - Anti-bacterial
 - Anti-Allergic
 - Oil and water repellent, easy to clean
 - Fire Rates: B, S1, d0 (EN-13501)
- Acoustic Glass Door**
 - 12mm single piece tempered glass with 180° opening angle
 - 5+5mm acoustic laminated glass on the back special for absorbing low frequency vibration
- Basotect FR Foam**
 - Located below fabric layers, BASF Basotect Fire Resistance Foam has high sound absorption capacity
- Seismic Foot Plates**
 - Along with castors or fixed glides, Apod X models also have foot plates for securing the pod placements and fix to the ground

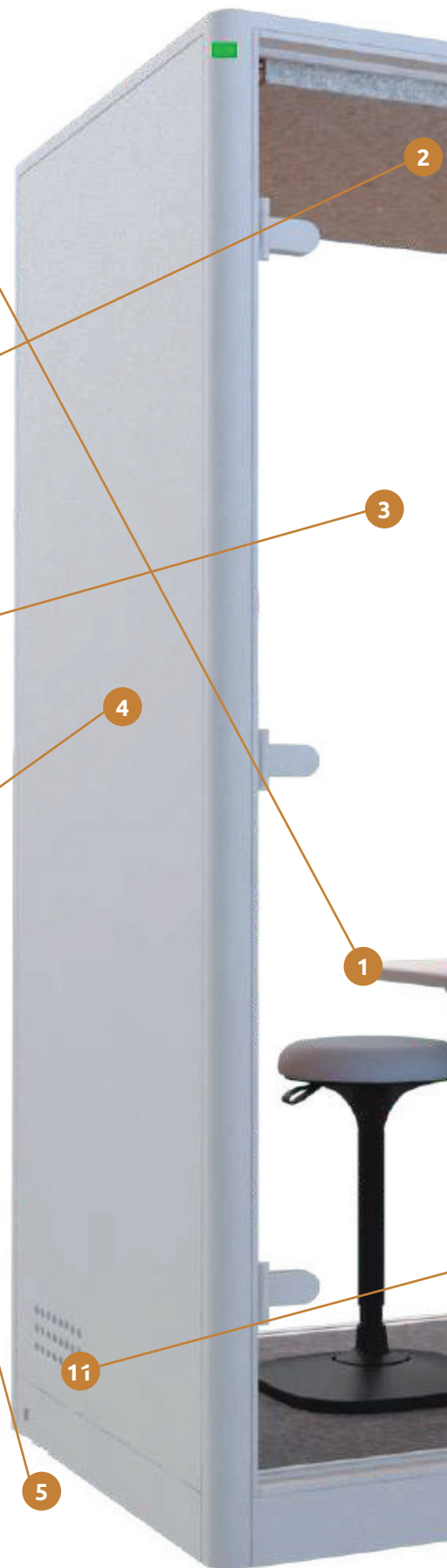

*Only available for Apod X Small

**Lux measurement standards are based on values from table top surfaces.

***Only available if height adjustable tables are selected.

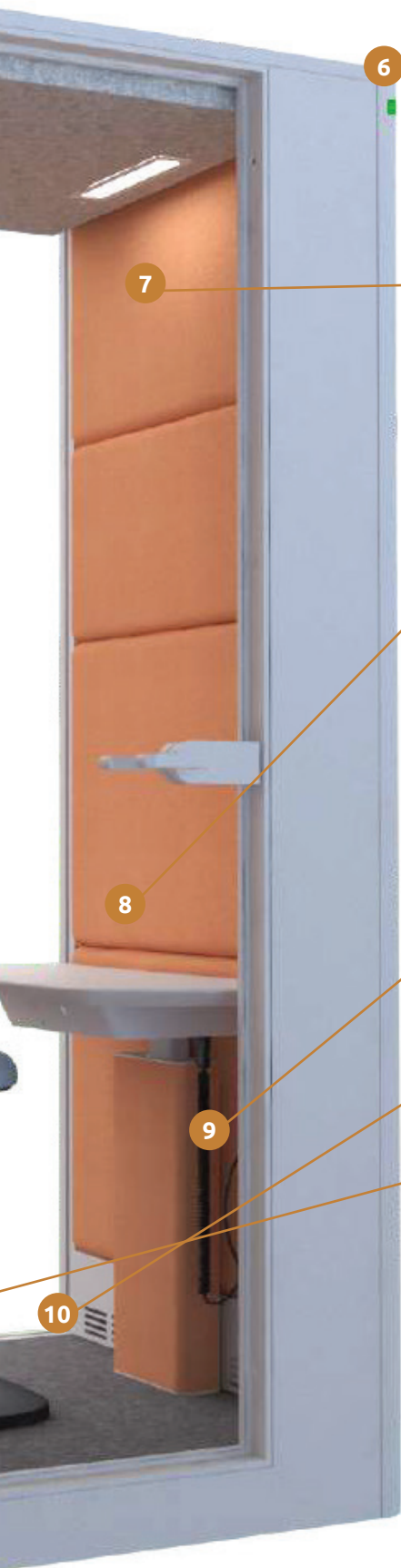

6 PIR Sensor Activated Systems

Dimmer LEDs
Air Ventilation Fans
Occupancy Indicators (Optional, lighting in Red and Green)

7 Dimmable LED Lights

Dimmer LEDs
6,2W
168 lm/W
3000K Daylight Hue
Min 20 Lux - Max 170 Lux**

8 Table Top Sockets / Media Wall Sockets

1 unit Socket
1 unit USB-A+C Type
1 unit 3000 mm RJ45 Ethernet Type Data Cable (can be mounted to the ceiling or floor)
Compatible up to 500 W devices
Standard black plastic with powder coated aluminum frame
(Electrical options may vary for each Apod X model. Please see the Electrical Specifications page for detailed information.)

9 Spiral Cable Extention

Height Adjustable table with, 500 mm length with GST18 Socket Connection***







10 Air Ventilation

Air flow per fan 182,5 m

11 Main Power Unit

Input Cables:
3000mm input cable 220V-230V EURO Plug Type, Standard Black Color
Main Power Unit is placed on the lower left or back side of the product when faced up front
Total Power Consumption is 17 Watts*

***When the lights and fans are fully working.**

		Apod X small	Apod X Zoom	Apod X Large	Apod X Four	Apod Double X	Apod Triple X
							
Apod X Sizes	exterior	100x110 h227	100x140 h227	100x220 h227	140x220 h227	180x220 h227	220x270 h227
	interior	93x91,5 h204,7	123x88 h204,7	93x205 h204,7	133x204,4 h204,7	173x204,4 h204,7	263x204,4 h204,7
Soft seating option		-	Standard	Optional	Standard	-	-
User Capacity		1	1	2	4	4	4-6
Air Fans		2 pcs	2 pcs	4 pcs	6 pcs	8 pcs	12 pcs
Wheels	castors	4 pcs	4 pcs	4 pcs	4 pcs	-	-
	fixed feet	4 pcs	5 pcs	8 pcs	8 pcs	16 pcs	24 pcs
Table top		Optional 37x82	Optional 43,2x88	Optional 50x70	Optional 68x90	Optional	Optional

Packaging size

Apod X small

116x228x60
400 kgs crate
70x70x100
25 kgs box

Apod X Zoom

107x228x85
450 kgs crate
95x72x100
45 kgs box

Apod X Large

107x228x95
600 kgs crate
90x140x100+
70x70x100
70 or 30 kgs box*

Apod X Four

147x228x90
750 kgs crate
90x140x100
90 kgs box

Apod Double X

107x228x85
800 kgs 2 crates
180x70x60
70 kgs box

Apod Triple X

107x228x95
1000 kgs 2 crates
90x140x100
80 kgs box



* For Apod X Large packages; 70 kgs box if soft seating is included, 30 kgs if not.

Electrical specification



The RJ45 Ethernet Data Cable can be used from the floor or the ceiling of the product.

Considering the viewer distance, we recommend using a 27 inch TV screen. TV Screens are not included in Apod X products.

If the optional TV Bracket is selected, a cable path for HDMI entry and an additional socket for the TV plug is also integrated.

		Apod X small 	Apod X Zoom 	Apod X Large 	Apod X Four 	Apod Double X 	Apod Triple X 
RJ45 Ethernet Entry	Under the table		1 pcs	1 pcs	1 pcs	1 pcs	1 pcs
Power Socket	Optional Desktop Socket*		1 pcs (if mediawall is included 2 pcs)	2 pcs	2 pcs	2 pcs	2 pcs
Total Power Consumption	17W		17W (if mediawall is included, 29W)	21W	34W	42W	63W
USB A/ USB C	Optional Desktop Socket		1 USB A 1 USB C	1 USB A 1 USB C	1 USB A 1 USB C	1 USB A 1 USB C	1 USB A 1 USB C
HDMI*	-		-	Optional with TV braket (1 pc)	Optional with TV braket (1 pc)	Optional with TV braket (1 pc)	Optional with TV braket (1 pc)
Media Wall*	-		Compatible with screen up to 27 inches	-	-	-	-
TV Bracket*	-		-	Optional	Optional	Optional	Optional

*Optional features may create additional costs added to the basic price of the product.

**Refresh
yourself in
every breath.**

Apod X

Air flow



The air exchange rate reflects how frequently the cabin experiences complete air changes. This rate is expressed as the number of air exchanges per hour. According to the data, the cabin is ventilated at a rate of 85 air units/hour. This value is pivotal in understanding how often the cabin's indoor air is replaced by fresh air, which is vital for maintaining indoor air quality. The air inlet area is a crucial factor in achieving effective cabin ventilation and enhanced indoor air quality. A larger air inlet area could indicate the need for a higher air exchange rate, ensuring consistent renewal of indoor air and the provision of fresh air.

Air Exchange Period
every 42 seconds

Air Flow Rate
85 CFM

Air Inflow
144,7 m³/h



Materials

Exterior Colours - MDF Powder Coating



Grey

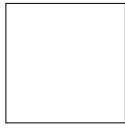

White



Black



Sand



Soft green

Carpet Colours



CORAL 350

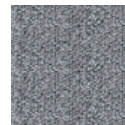

CORAL 342

Interior Felt Colours (Standard)



LIGHT
GREY FLT02

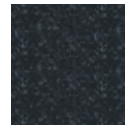

DARK GREY
FLT03

Interior Fabric Colours - Era (Standard)

Brand: Camira **Composition:** 100% PES **Abrasion:** 100.000 **Weight:** 320 gr/m2 **Pilling:** 4



NU-A3-16



NU-A3-15



NU-A3-08



NU-A3-03



NU-A3-20



NU-A3-25



NU-A3-29



NU-A3-34



NU-A3-36

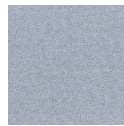

NU-A3-39



NU-A3-42

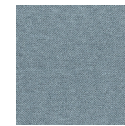

NU-A3-43

Interior Fabric Colours - Blazer (Optional)

Brand: Camira **Composition:** 100% virgin wool **Abrasion:** 50.000 **Weight:** 460 gr/m2 **Pilling:** 4

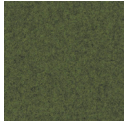

NU-D1-1K



NU-D1-1L



NU-D1-1R



NU-D1-1W



NU-D1-002



NU-D1-008



NU-D1-012



NU-D1-021

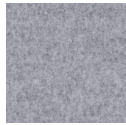

NU-D1-028



NU-D1-035



NU-D1-039



NU-D1-047



NU-D1-063



NU-D1-082

Table Top Colours



White



Grey

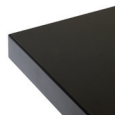

Black

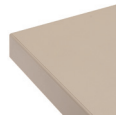

Sand*

Table Base Colours

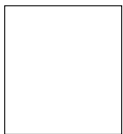

White









Black



Silver

*only available for the Apod X Small, Zoom & Four

Fabric Specifications

Era	Blazer
  	  
<p>100% Polyester</p>	<p>100% Virgin Wool</p>
<p>Weight: 320 g/m2 ±5%</p> <p>Fastness to Rubbing: Wet: 4, Dry: 4 (ISO 105 - X12)</p> <p>Light Fastness: 5 (ISO 105 - B02)</p>	<p>Weight: 460 g/m2 ±5%</p> <p>Fastness to Rubbing: Wet: 4, Dry: 4 (ISO 105 - X12)</p> <p>Light Fastness: 4-6 (ISO 105 - B02)</p>
<p>Flammability</p>	<p>Flammability</p>
<p>BS 7176 Low Hazard</p> <p>EN 1021 - 1&2 (cigarette & match)</p> <p>EN 13501-1 Adhered Class B, s1, d0</p> <p>EN 13501-1 Un-adhered Class C, s1, d0</p> <p>BS 7176 Medium Hazard with EnviroFlam5</p> <p>BS 5852 Ignition Source 5 with EnviroFlam5</p> <p>The Furniture & Furnishing (Fire Safety) Regulations 1988 (UK domestic cig & match) with EnviroFlam5</p>	<p>EN 1021 - 1&2 (cigarette & match)</p> <p>BS 7176 Low Hazard</p> <p>NF D 60-013</p> <p>ÖNORM B 3825 & A 3800-1 (over CMHR 58kg/m3 Foam)</p> <p>UNI 9175 Classe 1 IM</p> <p>BS 476 Part 7 Class 1 (Adhered)</p> <p>EN 13501-1 Adhered Class D, s1, d0</p> <p>IMO FTP Code (Part 8)</p> <p>The Furniture and Furnishing (Fire Safety) Regulations 1988 (UK domestic cigarette and match)</p> <p>BS 5852 Ignition Source 5 when FR treated</p> <p>BS 7176 Medium Hazard when FR treated</p> <p>BS 476 Part 6 Class 0 when FR treated (Adhered)</p> <p>EN 13501-1 Adhered Class B, s1, d0 when FR treated</p> <p>EN 13501-1 Un-adhered Class D, s2, d0 when FR treated</p> <p>BS 5867-2 Type B Curtains & Drapes when FR treated</p> <p>EN 13773 Class 1 (when FR treated)</p>



Recommendations

Please make sure to keep in mind our recommendations and guides when using / installing or moving Apod X products.

- Do not plug and appliances more than 220-230 VAC.
- Make sure the Apod X is not plugged in before you open the access cover on top.

The ventilation and lights work at the same time, make sure the lights are on when you

- are in the pod.

Do not block the vent grill, keep 20 cm distances between Apod X products and walls.

- To have better access to air, we also recommend having 20 cm space distance between the ceiling and pod.
- Keep the door closed at all times.
- Do not smoke inside.
- Keep fire sources away from Apod X at all times.
- Do not install high power-consuming devices such as heaters or vacuum cleaners inside the Apod X. The maximum power outlet capacity is 500W.

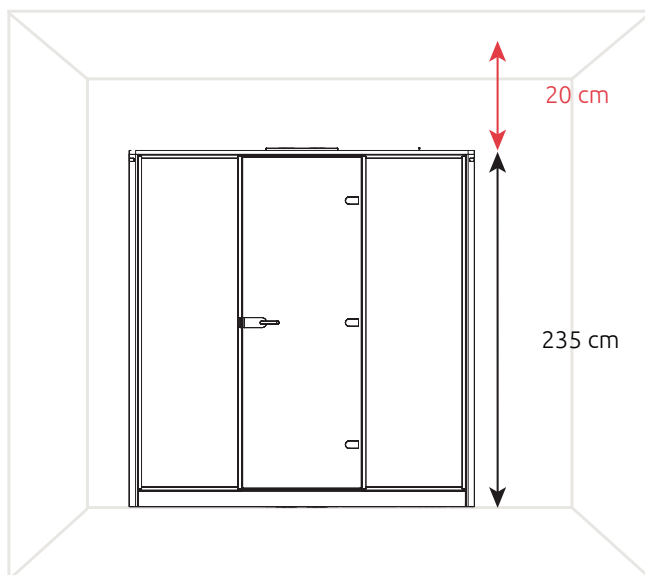

Please make sure to have some space between Apod X products and their surroundings for a healthy air flow circulation. The minimum space requirement for the height of Apod X models is 235 cm.

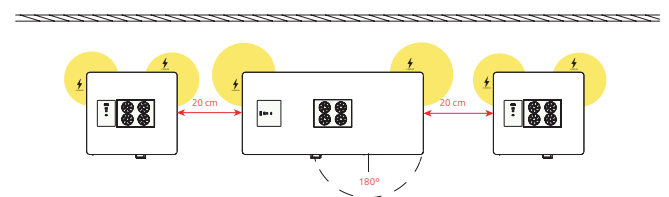

When placing Apod X units, make sure the bottom left or the back panel is close to a power source.

Analysis & reports

C02 Level

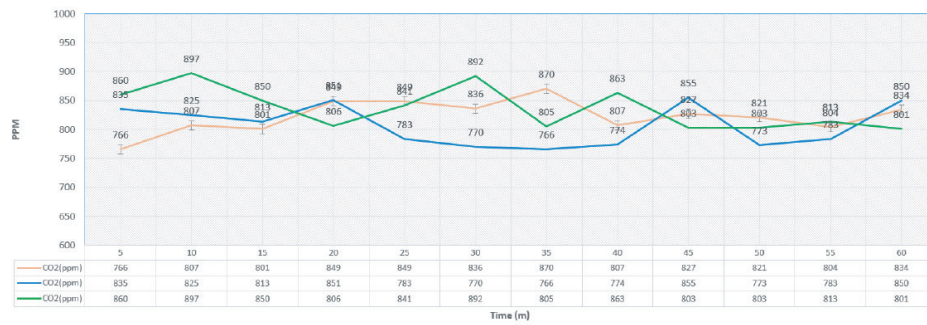

Humidity (%)

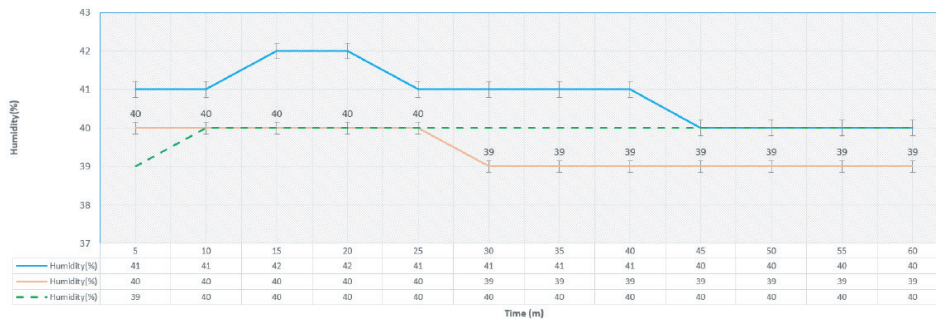

Temperature

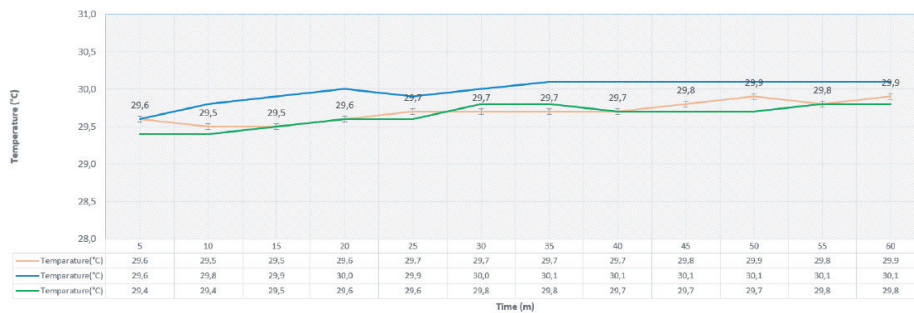

Additional information



Apod X Small

- Fan dim
- Light switch
- USB A+C
- Ethernet cable input



Apod X Zoom

- Fan dim
- Light switch
- Power
- Ethernet cable input

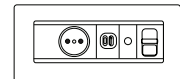

Apod X Large

- Fan dim
- Light switch
- 2x power
- USB A+C
- USB C
- Ethernet cable input

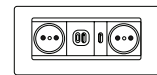
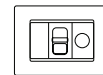

Apod X Four

- Fan dim
- Light switch
- 2x power
- USB A+C
- USB C
- Ethernet cable input

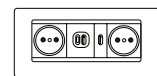
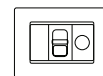

Apod Double X

- Fan dim
- Light switch
- 2x power
- USB A+C
- USB C
- Ethernet cable input

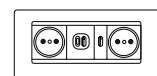
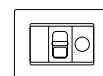

Apod Triple X

- Fan dim
- Light switch
- 2x power
- USB A+C
- USB C
- Ethernet cable input

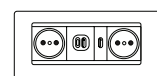
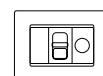

*When TV Bracket option for Apod X's models is selected (only available for 220cm width), the USB-C module placed on the power socket will be replaced with an HDMI socket instead. Also 1 socket for TV and 1 HDMI cable tunnel will be added on the panel for TV integration.

Accessories

Power socket

The integration of design and engineering.

Power socket system provides an easy to use integration of your electronic devices with your furniture.

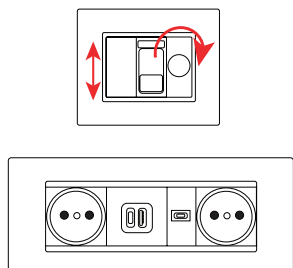

A standard power socket set for Apod X includes:

- 1 pc RJ45 Ethernet Data Entry (with sliding cover)
- 2 pcs 220VAC Power Socket (Max Output Power 500W)
- 1 pc USB A+C 15W
- 1 pc USB C
- 1 pc dimmer switch used for fan acceleration

Additional components stated below are included in case of TV Bracket option:

- 1 pc HDMI Entry (with HDMI integration one pc USB C is removed)
- 1 pc power socket for the TV extra

For the light switch, there are multiple settings:

- 1 Click: ON / OFF
- Click and Hold: Increase / Decrease Lights
- 2 Clicks: Save and set the current light setting as standard

Media Hub

With GST18 connection

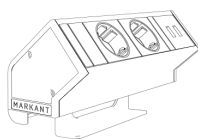

- Plug type: NL or BE/FR
- Media Hub options:
 - 3x power
 - 2x power, 2x USB A
 - 2x power, 1x USB A, x USB C

TV Bracket

This component is only available for the Apod X models with a 220 cm width.

We recommend placing a 27 inch TV. The maximum TV size is 32 inch.

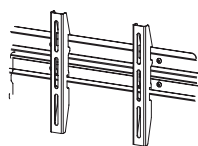

Media Wall
(only available for
Apod X Zoom)

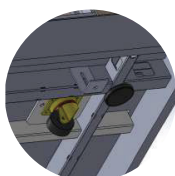

Seismic Foot Plates



Height Adjustable Table
(only available for
Apod X Small)



Power Socket

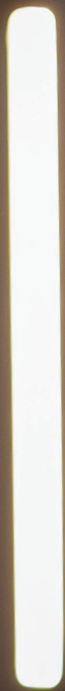
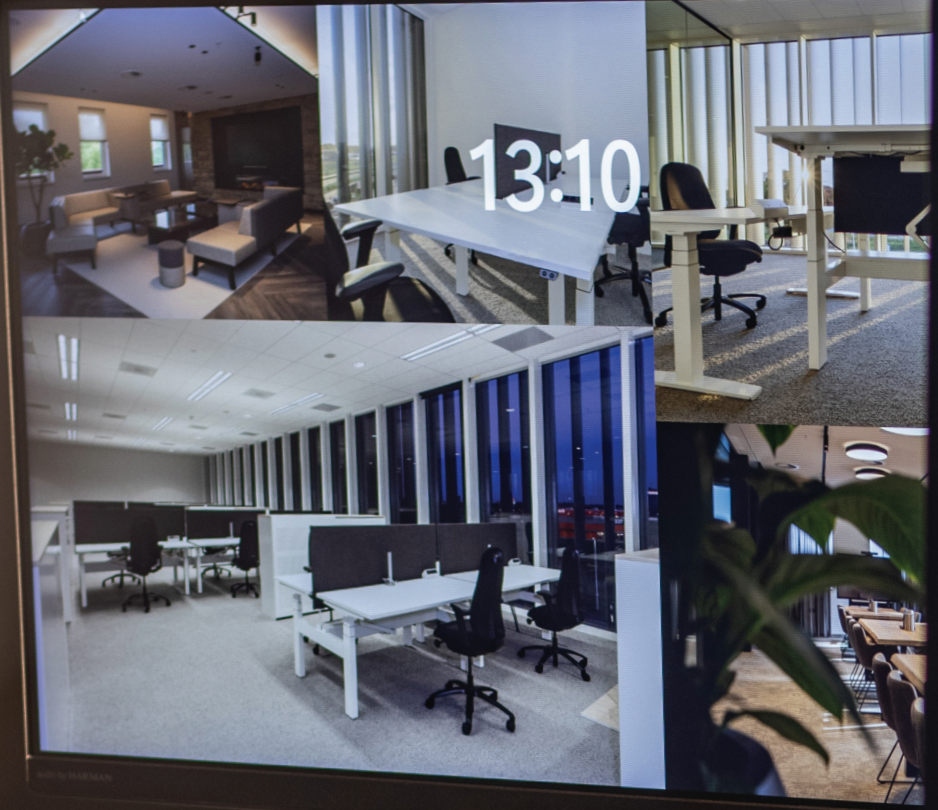

Apod X

Media Wall

Media Wall is an optional component only available for the Apod X Zoom.

A standard power socket attached to the media wall includes:

- 1 pc 220 VAC power socket (Max Output Power 500W)
- 1 pc dimmer switch used for fan acceleration
- 1 pc USB A+C
- 1 light switch for ceiling lights and 1 light switch for lights next to the screen
 - 1 Click: ON / OFF
 - Click and Hold: Increase / Decrease Lights
 - 2 Clicks: Save and set the current light setting as standard

Behind the screen there are two standard connections.

- 1 pc 220 VAC power socket (for mounting screen or TVs)
- 1 pc RJ45 Ethernet Type Data Entry

**Please note that TV, Screen or monitors are not included nor attached to the media wall unit.*

Maximum 27 inches screens can be mounted to the existing unit afterwards.

MARKANT

'It's about the way you work'

T +31 (0) 30 693 69 69

E sales@markantoffice.com

markantoffice.com